

Corredera en línea 85RT+

Secciones Técnicas

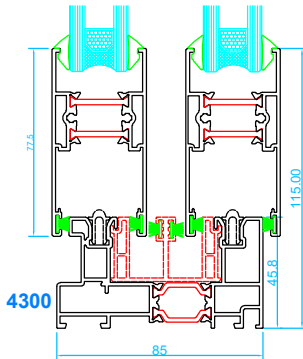

Marco de corredera
Hoja de corredera

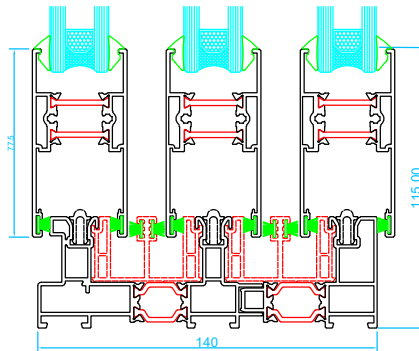

Marco de corredera de triple carril
Hoja de corredera

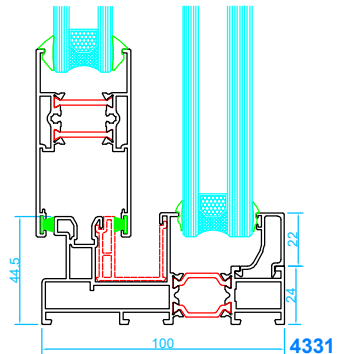

Marco de corredera con 1 hoja fija

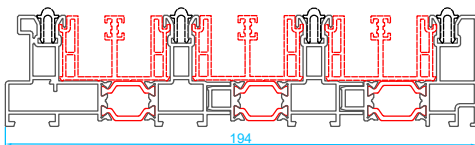

Marco 4 carriles, posibilidad de marcos combinables, hasta 12 carriles.

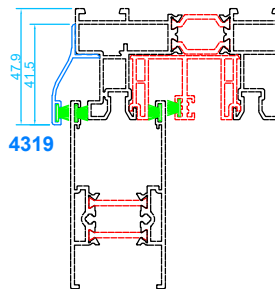

Goterón para evitar filtraciones de agua a ras de fachada

Nudos centrales

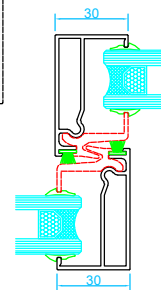

Cruce estándar

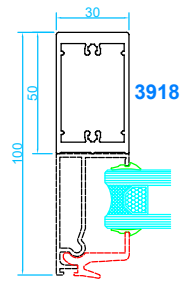

Cruce con refuerzo de inercia

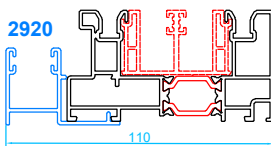

Guía de persiana especial reducida

Perfiles de unión

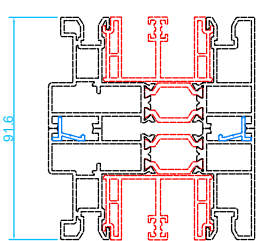

Unión invisible

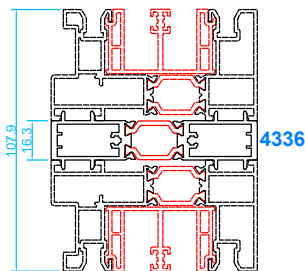

Unión marco con marco corredera

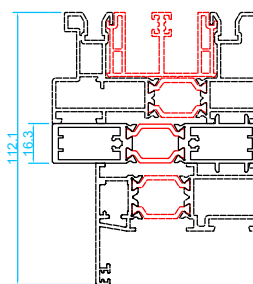

Unión marco corredera con fijo

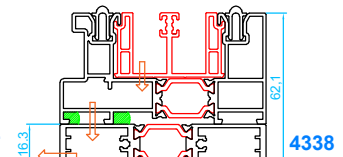

4338

En casos de ventanales situados en zonas muy expuestas a pluviales, existe la posibilidad de instalar el perfil 4338 como suplemento de marco. Este perfil permite obtener una mayor altura de marco inferior. Al realizar el desagüe INDIRECTO a través de este perfil, se consigue una mayor columna de agua, pudiendo desalojar un mayor caudal de agua en condiciones de presión de viento desfavorables.

Tapajuntas

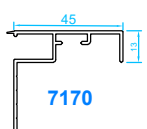

7170

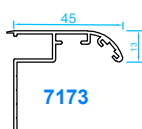

7173

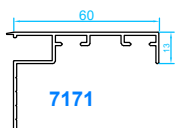

7171

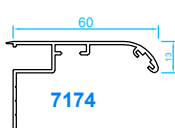

7174

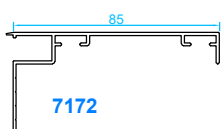

7172

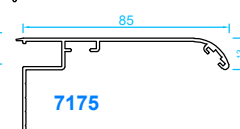

7175

Travesaños

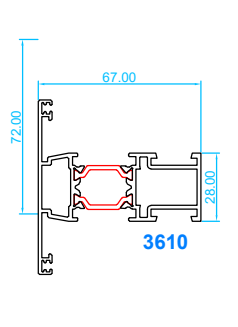

3610

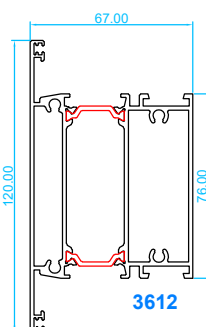

3612

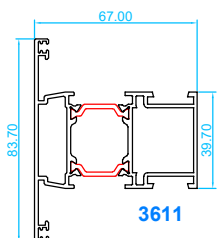

3611